













MDT Series

Pressure transmitters with integrated amplifier
for high temperatures and high pressures

Operating Manual



Table of Contents

Content	Chapter	Page	Icon
General	1	3	
Notes on safety	2	5	
Technical data	3	6	
Function	4	13	
Transport/delivery	5	15	
Installation	6	16	
Commissioning	7	25	
Maintenance	8	27	
Accessories	9	29	
Troubleshooting	10	30	
CE- Declaration of conformity	11	31	



1. General



- 1.1 Important information 3
- 1.2 Copyright 4
- 1.3 Explanation of icons 4
- 1.4 Abbreviations 4
- 1.5 Correct use 5
- 1.6 User's obligations 5

1.1 Important information

This manual applies to the MDT 420x/460x and PT 420x/460x series only. It must be kept near the equipment in a readily and immediately accessible location at all times.

The content of this manual must be read, understood and followed in all points by all relevant people. This applies in particular to the notes on safety. Following the safety instructions will help to prevent accidents, defects and malfunctions.

DYNISCO will not be held liable for any injury, loss or damage resulting from failure to follow the instructions in this manual.

If malfunctions occur in spite of having followed the operating instructions, please contact the **DYNISCO** customer service department (see chapter 8, Maintenance).

This applies in particular during the warranty period.



1.2 Copyright



Copyright law requires that this manual be used for inhouse purposes only.

All reproduction, even partially and for in-house purposes, requires the approval of **DYNISCO**. This manual may not be forwarded to third parties.

1.3 Explanation of icons

The manual uses icons to indicate information pertaining to safety:

ATTENTION Risk of destruction or damage to equipment, machines or installations



General danger to life or limb



Specific danger to life or limb



You **MUST** do this

The safety instructions are provided again in the individual chapters of the manual.

1.4 Abbreviations

The following abbreviations are used:

OM	Operating manual
PT	pressure transmitter
f.s.	of full scale



1.5 Correct use



The purpose of the MDT or PT 420x/460x pressure transmitter is to measure pressure in plastic melt as part of a larger overall system. It contains an integrated signal amplifier. The standard MDT or PT 420x/460x can be used in media temperatures up to 400°C.

If the PT is used in other applications, the safety and accident prevention regulations specific to that application must be followed.

The PT can not be used as a safety component!

1.6 User's obligations

The operator or owner of the larger overall system, e.g. a machine, is responsible for following the safety and accident prevention regulations that apply to the specific application.

2. Notes on safety



The operator or owner of the larger overall system is responsible for following the safety and accident prevention regulations that apply to the specific application.



Toxic hazard!

(Only when using standard models with mercury) The PT contains a small amount (7 mm³) of mercury (Hg) as its transmission medium. If the diaphragm is damaged, mercury may escape.

Never transport or store the PT without the protective shell bolted in place. Remove the shell shortly before installation.

If mercury is inhaled or swallowed, seek medical attention immediately!

Mercury is hazardous waste and must be disposed of in accordance with applicable laws. DYNISCO will accept defective PTs. If mercury escapes, use airtight packaging! Alternative, non-toxic transmission media (Oil or NaK) available on request.



When planning machinery and using the PT, follow the safety and accident prevention regulations that apply to your application, e.g.:

- EN 60204, Electrical equipment in machines.
- EN 292, Machine safety, general design guidelines.
- DIN 57 100 Part 410, Protection against electric shock.



Mounting and electrical connection of the PT must be done by specialists with EMC training, following all applicable regulations, and in pressureless, voltage-free condition with the machine switched off.

The machine must be secured against being switched back on!



Burn hazard!

The PT must be removed with the melt in molten condition. The PT can be very hot when removed.



Wear protective gloves!

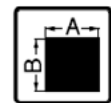

3. Technical Data

3.1 Ordering guide	7
3.2 Ordering example	7
3.3 Performance characteristics	8
3.3.1 Accuracy	8
3.3.2 Repeatability	8
3.3.3 Resolution	8
3.4 Mechanical configurations	8
3.5 Pressure side connection	8



3.6 Pressure ranges	8
3.6.1 Pressure ranges in bar	9
3.6.2 Max. Overload	9
3.6.3 Burst pressure	9
3.6.4 Limit frequency	9
3.7 Rigid stem/flexible stem	9
3.8 Electrical Data	10
3.9 Temperature influence	10
3.10 EMC requirements	11
3.11 Materials	11
3.12 Mounting torque	11
3.13 Environmental Protection	12
3.14 Weight	12
3.15 Dimensions	12

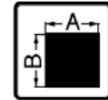

3.1 Ordering guide

xDT4xx x- xx - xxx - x - Option

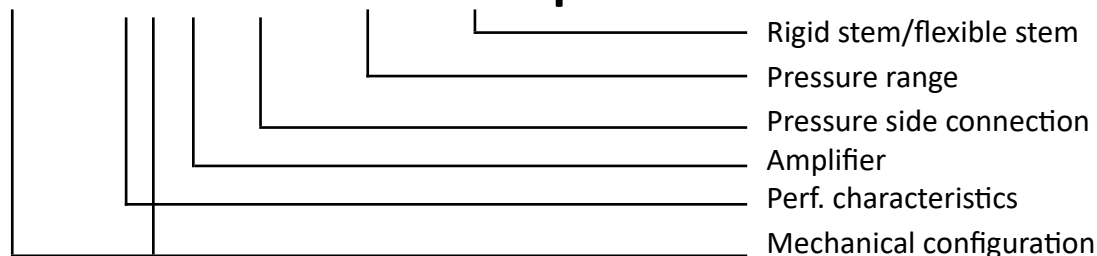

The exact meanings of the letter/digit combinations are given in the corresponding sections of chapter 3.

3.2 Ordering example

MDT462 F - ½ - 5C - 15/46

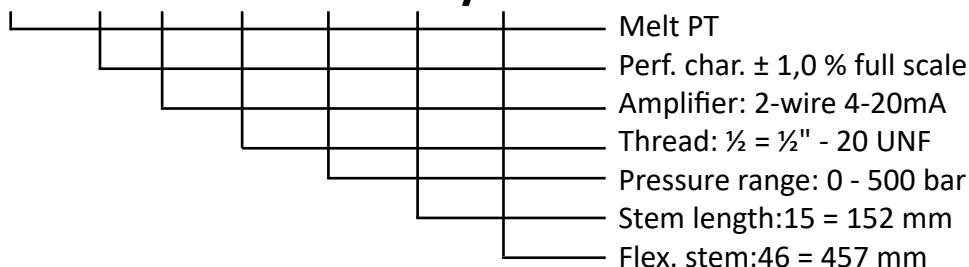



3.3 Performance characteristics (xDT4Xx x-xx-xxx-xx)

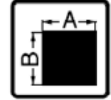

3.3.1 Accuracy

(Linearity and hysteresis at T = constant)

xDT42x x	± 0,5 % of full scale
(35 bar and 50 bar	± 1 % of full scale)
xDT46x x	± 1 % of full scale

3.3.2 Repeatability

xDT42x x	± 0,1 % of full scale
(35 bar and 50 bar	± 0,2 % of full scale)
xDT46x x	± 0,2 % of full scale

3.3.3 Resolution

infinite

3.4 Mechanical configurations (XDT4xX x-xx-xxx-xx)

MDT4x0	stem version
MDT4x2	rigid stem and flexible stem
TDT432/463	combined pressure and temperature measurement
MDT435/467	transducer for limited installation space

3.5 Pressure side connection (xDT4xx x-XX-xxx-xx)

½ = ½" 20 UNF 2A
M18 = M18 x 1,5

3.6 Pressure ranges (xDT4xx x-xx-XXX-xx)



3.6.1 Pressure ranges in bar

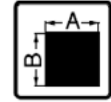

Model number	Permitted pressure range in bar
xDT4xx x-xx-17-xx	0 - 17 series 42x x/43x x only
xDT4xx x-xx-35-xx	0 - 35 series 42x x/43x x only
xDT4xx x-xx-50-xx	0 - 50 series 42x x/43x x only
xDT4xx x-xx-1C-xx	0 - 100
xDT4xx x-xx-2C-xx	0 - 200
xDT4xx x-xx-3,5C-xx	0 - 350
xDT4xx x-xx-5C-xx	0 - 500
xDT4xx x-xx-7C-xx	0 - 700
xDT4xx x-xx-1M-xx	0 - 1000
xDT4xx x-xx-1,4M-xx	0 - 1400
xDT4xx x-xx-2M-xx	0 - 2000
Other pressure ranges on request	

3.6.2 Max. Overload (without influencing operating data)

2 x full scale pressure up to 700 bar (for 1000 bar and 1400 bar range: max. 1750 bar, and 2450 bar for the 2000 bar range)

3.6.3 Burst pressure 6 x nominal value,
max. 3000 bar

3.6.4 Limit frequency 50 Hz [-3db]

3.7 Rigid stem/flexible stem (xDT4xx x-xx-xxx-XX)

15 = 152 mm standard length for rigid version

15/46 = 152 mm stem length / 457 mm flexible stem

Other lengths on request



3.8 Electrical data (xDT4xx X-xx-xxx-xx)

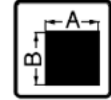

Configuration	4-arm Wheatstone bridge strain gauge with int. amplifier
Output signal	
xDT4xx F-xx-xxx-xx	2-wire 4 - 20 mA
(EMC: connecting cables defined as data lines)	
xDT4xx G-xx-xxx-xx	4-wire 0 - 5 VDC
xDT4xx H-xx-xxx-xx	4-wire 0 - 10 VDC
xDT4xx K-xx-xxx-xx	3-wire 0 - 5 VDC
xDT4xx L-xx-xxx-xx	3-wire 0 - 10 VDC
xDT4xx M-xx-xxx-xx	3-wire 1 - 6 VDC
xDT4xx N-xx-xxx-xx	3-wire 1 - 11 VDC
Strain resistance	
2 - wire mA	RL < 1200 Ω at US = 36 V RL < 50 Ω at US = 13 V
0 - 5 VDC	>5 kΩ
0 - 10 VDC	>10 kΩ
Supply voltage / power consumption	
2 - wire mA	10 - 36 VDC
3 - wire Volt	15 - 32 VDC
4 - wire Volt (unipolar)	19 - 32 VDC
4 - wire Volt (bipolar)	± 12 to ± 16 VDC
Calibration function (room temperature)	80 % ± 0,5 % of full scale output by externally connecting contacts E and F
Zero balance	± 5 %, min. - 2 % / + 5 % f.s for 2-wire
Range balance	± 5 % of full scale
Leakage resistance	> 1000 MΩ at 50 V

3.9 Temperature influence

Electronics housing

Max. housing temperature	-25 °C - +85 °C
Compensated temp. range	0 °C - +70 °C



Zero shift due to temperature change on electronics housing
 xDT 420 x series $\pm 0,2\%$ full scale / 10 °C typ.
 xDT 460 x series $\pm 0,2\%$ full scale / 10 °C typ.
 Sensitivity shift due to temperature change on electronics housing
 xDT 420 x series $\pm 0,2\%$ full scale / 10 °C typ.
 xDT 460 x series $\pm 0,2\%$ full scale / 10 °C typ.

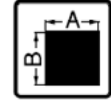

Diaphragm (in contact with media)

Maximum temperature at the diaphragm

Standard medium Hg 400 °C
 Transmission medium Oil 315 °C
 Transmission medium NaK 540°C

Zero shift due to temperature change on the diaphragm

xDT 420 x series <0,2 bar / 10 °C typ.
 xDT 460 x series < 0,4 bar / 10 °C typ.
 Sensitivity shift due to temperature change on the diaphragm
 xDT 420 x series < 0,1 % f. s. / 10 °C typ.
 (35 and 50 bar < 0,2 % f. s. / 10 °C typ.)
 xDT 460 x series < 0,4 % f. s. / 10 °C typ.

3.10 EMC requirements

Conforming to **CE** in accordance with EMC directive.

Emitted interference DIN EN 50081-1
 (residential area)
 Immunity DIN EN 50082-2
 (industrial area)

3.11 Materials

Diaphragm 15-5PH Mat.No. 1.4545
 Dymax coated
 Stem 15-5PH Mat.No. 1.4545

3.12 Mounting torque max. 50 Nm (500 inch-lbs.)
 min. 12 Nm (100 inch-lbs.)

3.13 Environmental protection to IEC 529

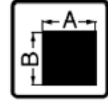

PT housing	IP54 (without connector)
Standard connector	
PT06A-10-6S(SR)	IP40
Connector PT06W-10-6S	IP64

3.14 Weight 1,1 kg

3.15 Dimensions

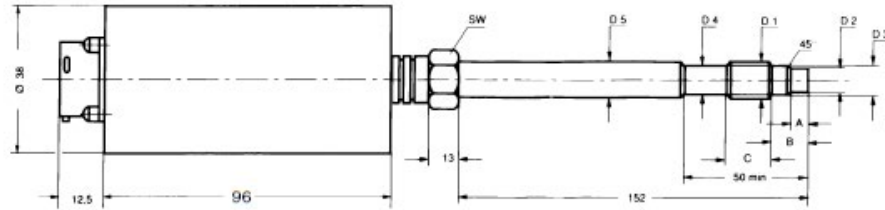

Fig. 01: MDT 420 x 460 x with fixed stem

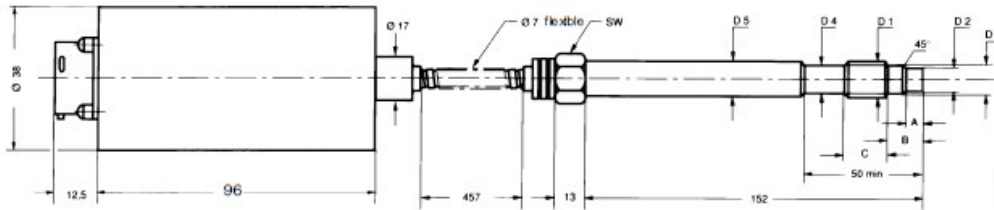

Fig. 02: MDT 422 x 462 x with flexible stem

D1	D2	D3	D4	D5	A	B	C	SW
1/2"-20UNF-2A M18 x 1,5	7,8 ^{-0,06} 10 ^{-0,05}	10,5 ^{-0,06} 16 ^{-0,1}	11 ^{-0,5} 16 ^{-0,5}	12,5 18	5,3 ^{+0,25} 6 ^{-0,25}	11 14	16 20	16 19

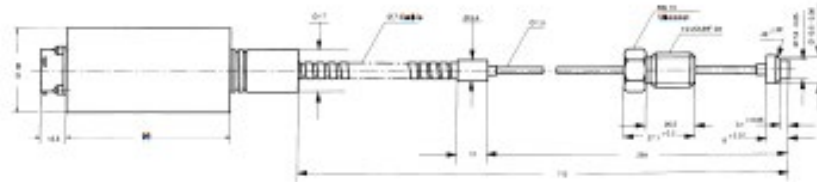

Fig. 03: MDT 435 x 467 x with supply

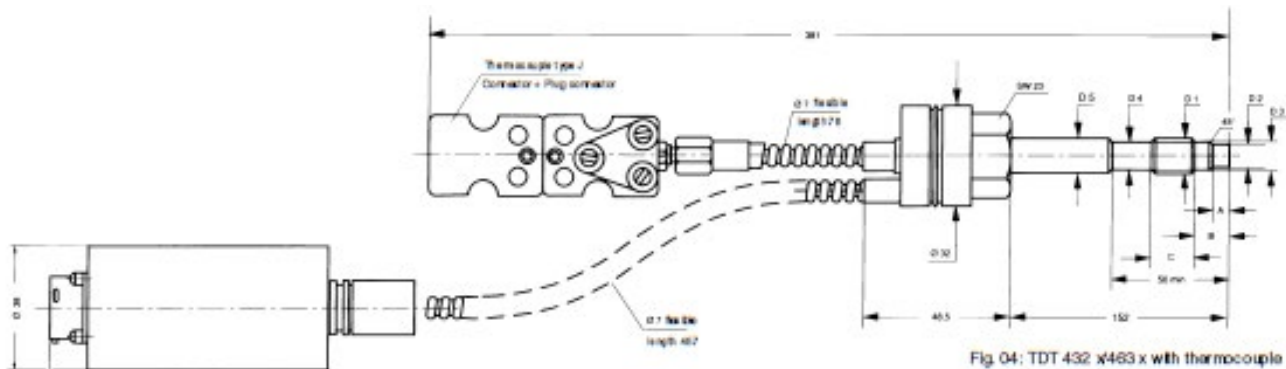
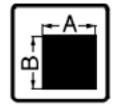

Fig. 04: TDT 432 x463 x with thermocouple

D1	D2	D3	D4	D5	A	B	C	SW
1/2"-20UNF-2A M18 x 1,5	7,8 ^{+0.08} 10 ^{+0.08}	10,5 ^{+0.08} 16 ^{+0.1}	11 ^{+0.1} 16 ^{+0.1}	12,5 18	5,3 ^{+0.08} 6 ^{+0.08}	11 14	16 20	16 19

4. Function

4.1 Construction	13
4.2 Description of functions	14
4.3 PT series	14



4.1 Construction

The PTs of series MDT 420 x/460 x are industry standard.

The main advantages are:

- manufactured under ISO 9001
- thermal stability
- resistance to aggressive media
- insensitivity to electromagnetic radiation (EMC)
- liquid-filled transmission system (mercury or other alternative liquids)
- pressure measurements in plastic melt up to a temperature of 400°C (750°F) (standard versions with mercury. Oil-filled versions 315°C, NaK-filled versions 540°C).
- maximum pressure 2000 bar

4.2 Description of functions



Through a closed, liquid-filled pressure transmission system, the PT furnishes an electrical signal that is proportional to the pressure of the melt.

The pressure applied by the medium is forwarded to the measuring diaphragm via the separating diaphragm and the transmission medium (standard configuration: mercury) in the capillary. The deflection of the measuring diaphragm changes the resistance of the strain gauge bonded to the measuring diaphragm. The strain gauge is a Wheatstone bridge.

Depending on the model, the integrated amplifier generates an electrical signal (mA or Volts) proportional to the pressure.

4.3 PT series

The MDT series PTs are also available as PT series. The PT types correspond to the MDT models, and the TPT types correspond to the TDT models; the number codes are identical. The PT series differs from the MDT series in that all specifications are given in US American units of measure.

E.g.: 1 bar = 14,5 PSI
 (PSI value is rounded)
 2,54 cm= 1" (inch)

All other specifications are the same as in the MDT series.

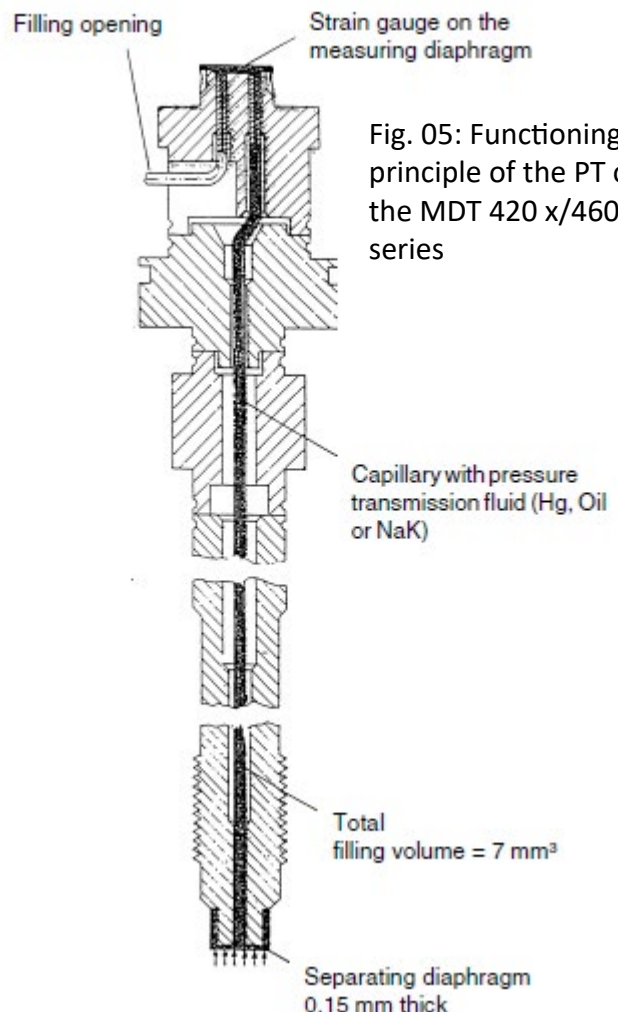

Fig. 05: Functioning principle of the PT of the MDT 420 x/460 x series



5. Transport / delivery



5.1 Transport / packing / transport damage	15
5.2 Storage	15
5.3 Scope of delivery	16



Toxic hazard!

(Only when using standard models with mercury)

The PT contains a small amount (7 mm³) of mercury (Hg) as its transmission medium. If the diaphragm is damaged, mercury may escape. Never transport or store the PT without the protective shell bolted in place. Remove the shell shortly before installation.

If mercury is inhaled or swallowed, seek medical attention immediately.

Mercury is hazardous waste and must be disposed of in accordance with applicable laws. **DYNISCO** will accept defective PTs.

If mercury escapes, use airtight packaging!

Alternative, non-toxic transmission media (Oil or NaK) available on request.

ATTENTION

ESD sensitive component. Electrostatic discharge may damage the PT. Take ESD precautions.

5.1 Transport/packing/transport damage

- Do not let the PT be damaged by other items during transit.
- Use only the original packaging.
- Report transport damage to **DYNISCO** immediately in writing.

5.2 Storage

- Store the PT in original packaging only.
- Protect against dust and moisture.



5.3 Scope of delivery



- PT with diaphragm protection cap
- Cable socket
- Fastening clip (transmitter with flexible stem only)
- Calibration sheet
- Operating manual

6. Installation



6.1 Mounting hole	16
6.2 Checking the mounting hole	18
6.3 Mounting the Pressure Transmitter	19
6.4 Mounting PTs with flexible stem	20
6.5 Electrical connection	21
6.5.1 EMC / CE compliant connection	21
6.6 Connection assignments	22
6.7 Wiring	23
6.8 Connection thermocouple /RTD element	24

ATTENTION

Ambient temperature for the electronics housing max. +85°C. Higher temperatures can result in damage and malfunctions. Mount the PT only in locations where these temperatures are not exceeded.

6.1 Mounting hole

ATTENTION

To produce the mounting hole, use only **DYNISCO** machining tool kit.

- Drill the mounting hole as shown in figure 06.

Fig. 06: Mounting hole for transmitter
MDT 420 x, 460 x, 422 x, 462 x, 432 x, 463 x

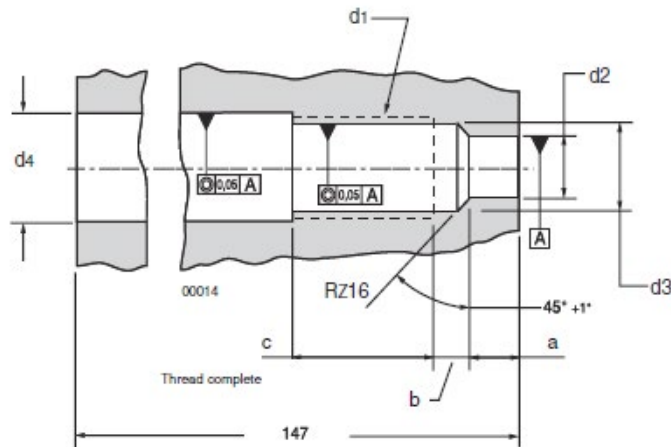

d_1	d_2	d_3	d_4	a	b	c
1/2"-20UNF-2B	$7,92^{+0,05}$	$11,5^{+0,1}$	13	5,7	4	19
M18 x 1,5	$10,1^{+0,05}$	$16,3^{+0,1}$	20	6,15	4	25

Fig. 07: Mounting hole for transmitter MDT467 x

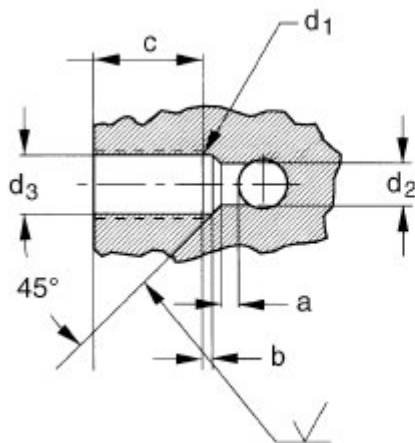

d_1	d_2	d_3
1/2"-20UNF-2B	$7,92^{+0,05}$	$11,5^{+0,2}$
a	b	c
3	1,5	17

When reworking the mounting hole, pay particular attention to the centricity of:

- the hole,
- the thread and
- the sealing surface.



Pressure sealing takes place on the 45° beveled sealing surface and on the front cylindrical section of the PT (see figures 06 and 07).

The sealing surface must be:

- correctly machined
- free from marks and rough edges
- free from solidified plastic residue.

6.2 Checking the mounting hole

- Paint the test bolt DYNISCO on the marked area (figure 08, item 1) with marking ink up to the thread.

Fig. 08: test bolt with marking ink



- Insert the test bolt in the mounting hole
- Twist it in by hand until the two sealing surfaces make contact.
- Remove and examine the test bolt.

The only acceptable abrasion of marking ink is at the sealing edge (45°), evenly (!) over the entire circumference.

If the ink has been rubbed off in other places too:

- rework the mounting hole.

6.3 Mounting the Pressure Transmitter



Mounting and electrical connection of the PT must be done by specialists with EMC training, following all applicable regulations, and in **pressureless, voltage-free** condition with the **machine switched off**.

The machine must be secured against being switched back on!
Toxic hazard!



(Only when using standard models with mercury)

The PT contains a small amount (7 mm³) of mercury (Hg) as its transmission medium. If the diaphragm is damaged, mercury may escape.

Never transport or store the PT without the protective shell bolted in place. Remove the shell shortly before installation.

If mercury is inhaled or swallowed, seek medical attention immediately!

Alternative, non-toxic transmission media (Oil or NaK) available on request.

ATTENTION

ESD sensitive component. Electrostatic discharge may damage the PT. Take ESD precautions.

ATTENTION

Before mounting the PT, check the mounting hole carefully. The PT must only be mounted in holes that satisfy the requirements stipulated in chapter 6.1. A hole that does not satisfy these requirements can damage the PT.

ATTENTION

Before mounting the PT, ensure that the mounting hole is free from plastic residue. Remove plastic residue with the **DYNISCO** cleaning tool kit. A test bolt is included with this cleaning set.

ATTENTION

To prevent the PT from sticking permanently in the mounting hole, coat the thread section of the transmitter with high temperature resistant grease or a suitable parting agent.

- Check the mounting hole with the test bolt, and clean with cleaning set if necessary.
- Coat the thread section of the transmitter with high temperature resistant grease or a suitable parting agent.

ATTENTION

Always use a spanner applied to the designated hexagon collar when screwing the PT in and out. Do not apply the tool to the housing or housing/sensor connection!



ATTENTION

Maximum mounting torque **50 Nm**. If the mounting torque is too high, the PT may be damaged or its zero point may shift.

- screw the PT into the mounting hole and tighten.

6.4 Mounting PTs with flexible stem

Mounting a PT with a flexible stem to the pressure sensor is done analogously to the procedure in 6.3.

ATTENTION

Avoid kinking or crushing the flexible stem.

Minimum bending radius

- 25 mm for protected capillary
- 2 mm for unprotected capillary
(MDT 435 x / 467 x)

The connector must be easily accessible.

- Mount the electronics housing of the PT with the fastening clip **DYNISCO P/N 200982** (included). See mounting example in figure 09.
- Additionally secure the flexible stem between the electronics housing with a standard cable clip.

Fig. 09: Mounting example for Pressure Transmitter with flexible stem

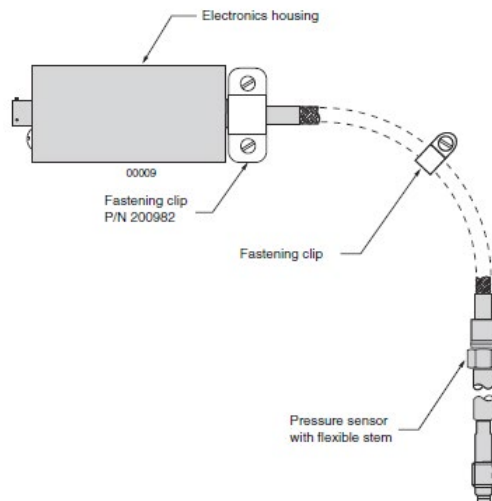

6.5 Electrical connection



ATTENTION

Mounting and electrical connection of the PT must be done by specialists with EMC training, following all applicable regulations, and in **pressureless, voltage-free** condition with the machine switched off.

The machine must be secured against being switched back on!

ESD sensitive component. Electrostatic discharge may damage the PT. Take ESD precautions.

ATTENTION

Avoid laying the power cable in the direct vicinity of cables carrying higher voltages or switching inductive or capacitive loads.

ATTENTION

An EMC compliant power supply must be used. The electrical connection must comply with EMC requirements.

ATTENTION

If the electrical connection is not made as described in chapter 6.5.1, or if cables / cable connectors / cable glands other than those stipulated by **DYNISCO** are used, **DYNISCO** cannot guarantee that EMC requirements will be satisfied.

6.5.1 EMC / ϵ compliant connection

- Earth the machine section with the screw-in trunnion / mounting hole for the PT in accordance with regulations. The PT must be connected to earth via the screw-in trunnion / mounting hole.
- Connect the shield of the connecting cable on both sides, making sure it conducts with full and continuous contact.
- When introducing the connecting cable into an EMC compliant switch cabinet, for example, connect the shield correctly (cable gland, conducting, full contact, continuous) to the conductive housing or route it via built-in cable connector that is also connected to the conductive housing.
- Connect unused cable cores or free cable ends correctly to the cable shield on both sides.

For order numbers of EMC compliant cable connectors required for connecting the PT, see chapter 9, Accessories.

6.6 Connection assignments

Standard models MDT 4xx x-xxx-xx:

Equipment connector: 6-pin male,
Bendix PT02A-10-6P
Cable socket: PT06A-10-6S(SR)



Fig. 10: 6-pin female connector

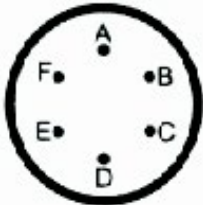

Top view solder side

PIN	Designation
A	signal (+)
B	signal (-)
C	supply voltage (+)
D	supply voltage (-)
E	calibration
F	calibration

The connector housing is connected conductively to the housing of the PT.

Modelle PT 4xx (PT 420 x/422 x/435 x/TPT432 x):

Equipment connector: 8-pin male,
Bendix PC02E-12-8P
Cable socket: PC06A-12-8S(SR)

Fig. 11: 8-pin female connector

Top view solder side

PIN	Designation
A	supply voltage (+)
B	signal (+)
C	supply voltage (-)
D	signal (-)
E	calibration
F	calibration
G	not used
H	not used

The connector housing is connected conductively to the housing of the PT.

6.7 Wiring



Fig. 12a: Wiring proposal 2-wire mA, floating mA indication with internal resistor $R_i < 44 \times U_S - 380$

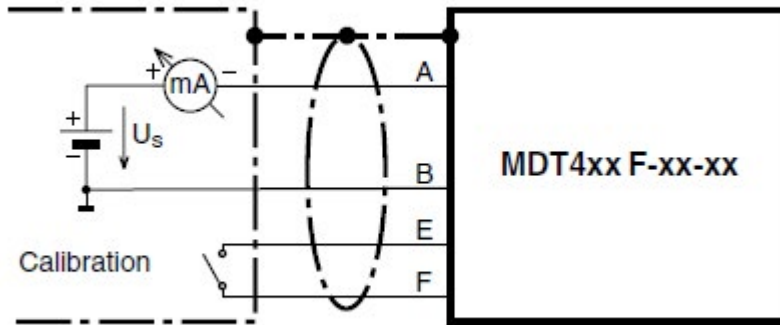

Fig. 12b: Wiring proposal 2-wire mA, mA indication with internal resistor $R_i < 44 \times U_S - 380$

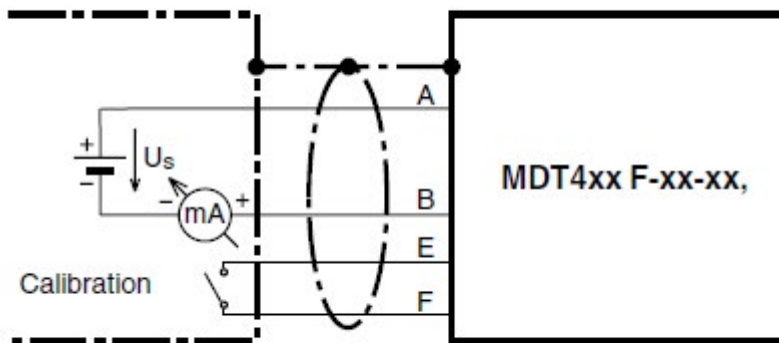

Fig. 13: Wiring proposal 3-wire Volts

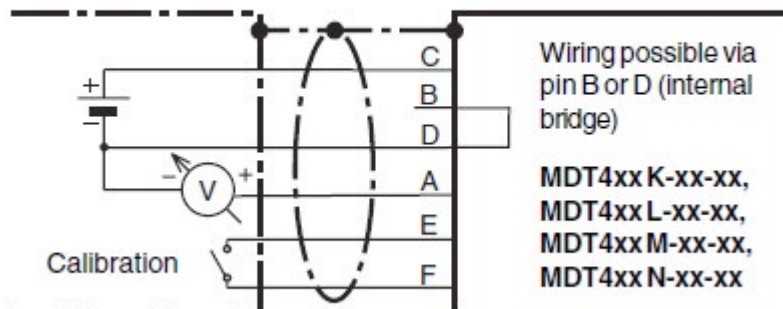

Fig. 14a: Wiring proposal 4-wire Volts (unipolar)

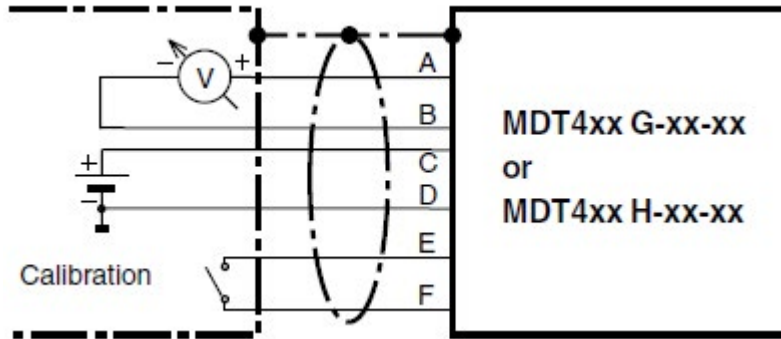
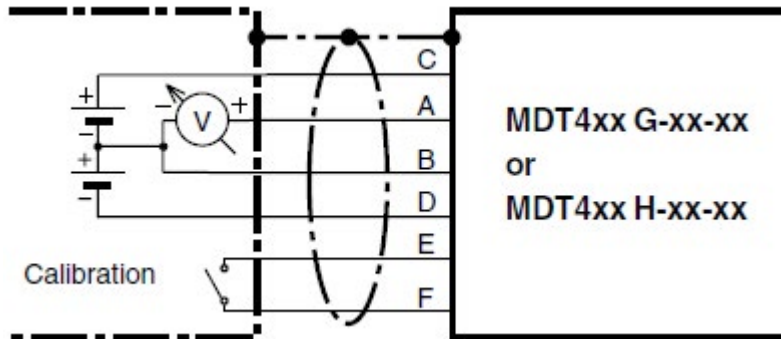

Fig. 14b: Wiring proposal 4-wire Volts (bipolar)



6.8 Connection thermocouple/RTD element (optional) MDT / TPT series

Fig. 15: Thermocouple connection

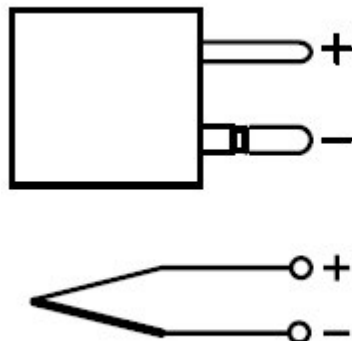
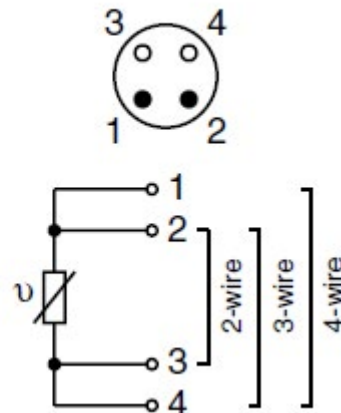

Fig. 16: RTD connection





7. Commissioning



7.1 Supply voltage	25
7.2 Calibration	25
7.3 Zero adjustment	26
7.4 Operation	26

ATTENTION

Before putting the PT into operation, make sure the PT is securely mounted and sealed.

7.1 Supply voltage

ATTENTION

Using a supply voltage which is different from that stated in the technical specifications or has reversed polarity can damage the PT or cause it to malfunction.

7.2 Calibration

PTs of series MDT 420 x/460 x have an internal calibration signal. Connecting terminals E and F switches the calibration signal to the signal output. It is 80% of the full scale pressure of the transmitter.

ATTENTION

Calibrate in pressureless state and at room temperature. Other ambient temperatures will corrupt the signal. Use an adjustment screwdriver!

ATTENTION

Do not change the installed position of the PT after calibration. If the position is changed you must re-calibrate the PT.

The adjustment is made at two potentiometer screws in the cover section of the electronic housing.

- Remove the cap screws from the potentiometers.

Potentiometer adjusting screw “N” for zero adjustment.

Potentiometer adjusting screw “B” for range adjustment.

Fig. 17: Electronics housing cover

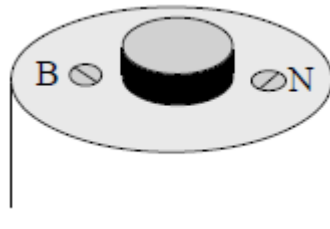

- Connect a meter or suitable instrument to the signal output to verify the settings.
- Adjust zero at potentiometer adjusting screw “N” and verify on the meter.
- Connect terminals E and F. The calibration signal is connected to the output.
- Adjust calibration value (80% of full scale pressure) at potentiometer adjusting screw “B” and verify on the meter.
- Check the zero setting again.
- Repeat the zero adjustment and calibration value as necessary.

7.3 Zero adjustment

For PTs of series MDT 420 x/460 x, adjust zero at operating temperature!

- Wait until a steady operating temperature is reached at the pressure sensor.
- Adjust zero at potentiometer adjusting screw “N” and verify on the meter.
- Replace the cover screws on the potentiometers.

7.4 Operation

ATTENTION

Before starting the machine, wait until the melt medium at the diaphragm of the PT has reached its operating / processing temperature. If the machine is started before the medium reaches its operating temperature, the PT will be damaged. If it is hard to tell when the operating temperature has been reached, use a combined TDT PT with thermocouple.



ATTENTION

Operating temperature at the PT diaphragm max. 400°C (750°F). Higher temperatures will damage the PT.



ATTENTION

Ambient temperature for the electronics housing max. +85°C. Higher temperatures can result in damage or malfunctions. Mount the PT only in locations where this temperature is not exceeded.

8. Maintenance



8.1 Maintenance	27
8.2 Thermocouple replacement TDT models	28
8.3 Repair/disposal	29

8.1 Maintenance



Mounting and electrical connection of the PT must be done by specialists with EMC training, following all applicable regulations, and in **pressureless, voltage-free** condition with the **machine switched off**.



The machine must be secured against being switched back on!
Burn hazard!



The PT must be removed with the melt in molten condition. The PT can be very hot when removed.

Wear protective gloves!

ESD sensitive component. Electrostatic discharge may damage the PT. Take ESD precautions.

ATTENTION

Always remove the PT before cleaning the machine with abrasives or steel wire brushes or suchlike.

ATTENTION

Before removing the PT, the medium must be in molten condition.

ATTENTION

Removing the transmitter with the medium in solidified condition can damage the diaphragm of the PT.

ATTENTION

Do not clean the screw-in section of the PT with hard objects. This will damage the PT!

ATTENTION

Always use a spanner applied to the designated hexagon collar when screwing the PT in and out. Do not apply the tool to the housing or housing/sensor connection!



- Remove the PT.
- Carefully clean the diaphragm of the transmitter with a soft cloth, while the medium is still malleable.

8.2 Thermocouple replacement TDT models

A defective thermocouple is easy to replace.

- Loosen the hexagon socket screw at the top end of the sensor stem.
- Remove the defective thermocouple from the probe stem.

ATTENTION

When fitting the new thermocouple, the pressure transmitting capillary must be located in the slot of the thermocouple.

- Insert the new thermocouple all the way into the probe stem.
- Tighten the hexagon socket screw at the top of the sensor stem to secure the thermocouple.

Fig. 18: Thermocouple

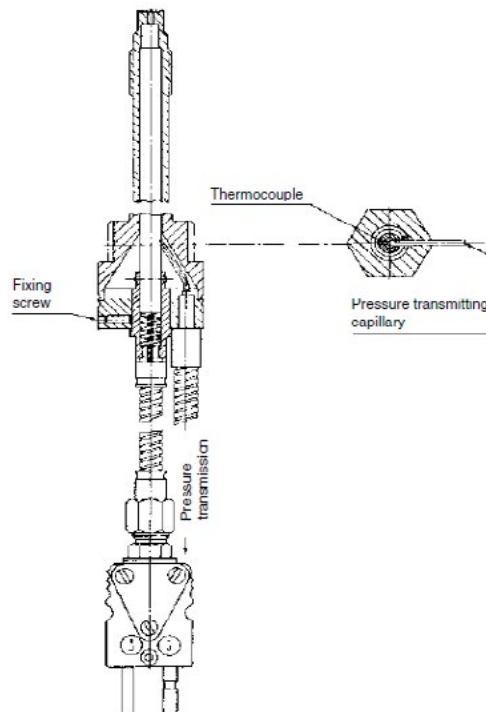



8.3 Repair/disposal



Toxic hazard!

(Only when using standard models with mercury)

The PT contains a small amount (7 mm³) of mercury (Hg) as its transmission medium. If the diaphragm is damaged, mercury may escape.

Never transport or store the PT without the protective shell bolted in place. Remove the shell shortly before installation.

If mercury is inhaled or swallowed, seek medical attention immediately!

Mercury is hazardous waste and must be disposed of in accordance with applicable laws. **DYNISCO** will accept defective PTs.

If mercury escapes, use airtight packaging!

Alternative, non-toxic transmission media (Oil or NaK) available on request.

Please send defective PTs to your **DYNISCO** representative.

For addresses, see the back cover of the operating manual.

9. Accessories



- Machining tool kit ½"-20UNF-2A
P/N 8BRD0004
- Machining tool kit M18 x 1,5
P/N 8BRD0005
- Cleaning tool kit ½"-20UNF-2A
P/N 8BRD0009
- Cleaning tool kit M18 x 1,5
P/N 8BRD0006
- Pressure sensor simulator
- Pressure sensor calibrating device



Connectors, Cable glands, Cable



Designation	Order No.
Female connector DIN 7.pin	E311 0035
Female connector Bendix	E311 0029
Cable gland PG 7 CE	E447 0037
Connecting cable VT 460 - 6 meter	9VT0 0017
Connecting cable VT 460 - 10 meter	9VT0 0018
Connecting cable VT 420 - 6 meter	9VT0 0005
Connecting cable VT 420 - 10 meter	9VT0 0007

10. Troubleshooting



10.1 Troubleshooting

Fault	Possible cause	Resolution
No signal	Cable breakage or poor contact No supply voltage	Check cable and contact, or replace Check supply voltage
Strong zero shift when screwing in	Mounting hole incorrectly produced (alignment error) Mounting torque too high	Check hole with test bolt (chapter 6.2), rework with tool if necessary Adjust to max. 50 Nm mounting torque
No signal change despite pressure rise	Plug forming in front of diaphragm Diaphragm damaged	Check mounting hole; remove solidified plastic Send pressure transmitter to DYNISCO for repair



11. Declaration of conformity





Konformitätserklärung

Declaration of conformity
Declaración de conformidad
Declaración de conformidad
Declaração de conformidade

Нормативні вимоги на, для якого процесу, тип:
von welcher Maschine/Teil aus produziert, Typ:
какое устройство для которого произведено изделие, тип:
para a qual máquina/peça para qual produto, tipo:
con il quale processo/strumento che il nostro prodotto tipo:
каким устройством или каким процессом, тип:
Нормативні вимоги на, для якого процесу, тип:
Me für welchen Prozess/Teil aus produziert, Typ:
para qual máquina/peça para qual produto, tipo:

регламент стандарта/норматива, тип:
con quale macchina/peça per il quale processo, tipo:
какое устройство/стандарт, тип:
para qual máquina/peça para qual produto, tipo:
con il quale processo/strumento che il nostro prodotto tipo:
каким устройством или каким процессом, тип:
Нормативні вимоги на, для якого процесу, тип:
Me für welchen Prozess/Teil aus produziert, Typ:
para qual máquina/peça para qual produto, tipo:

регламент стандарта/норматива, тип:
con quale macchina/peça per il quale processo, tipo:
какое устройство/стандарт, тип:
para qual máquina/peça para qual produto, tipo:
con il quale processo/strumento che il nostro prodotto tipo:
каким устройством или каким процессом, тип:
Нормативні вимоги на, для якого процесу, тип:
Me für welchen Prozess/Teil aus produziert, Typ:
para qual máquina/peça para qual produto, tipo:

Dichiarazione di conformità
Verklaring van overeenstemming
Konformitätserklärung
Англійська версія/переклад з ДІОК

Declaratie van conformiteit
Pressure Transmitter / Pressure Transducer
Serie MD1, EM1, ET1, MDA, IDA, TDA, LDA, PT, Dynal

регламент стандарта/норматива, тип:
con quale macchina/peça per il quale processo, tipo:
какое устройство/стандарт, тип:
para qual máquina/peça para qual produto, tipo:
con il quale processo/strumento che il nostro prodotto tipo:
каким устройством или каким процессом, тип:
Нормативні вимоги на, для якого процесу, тип:
Me für welchen Prozess/Teil aus produziert, Typ:
para qual máquina/peça para qual produto, tipo:

регламент стандарта/норматива, тип:
con quale macchina/peça per il quale processo, tipo:
какое устройство/стандарт, тип:
para qual máquina/peça para qual produto, tipo:
con il quale processo/strumento che il nostro prodotto tipo:
каким устройством или каким процессом, тип:
Нормативні вимоги на, для якого процесу, тип:
Me für welchen Prozess/Teil aus produziert, Typ:
para qual máquina/peça para qual produto, tipo:

Англіська версія/переклад з ДІОК: EN 60061-1 / EN 60061-2

Dynisco Europe GmbH
Wannenackerstraße 24
D 74078 Heilbronn
Tel. (+49 71 31) 2 97 - 0
Fax (+49 71 31) 2 32 60

Heilbronn, den 1. Mai 2008



Hans-Peter



Dynisco Instruments
38 Forge Parkway
Franklin, MA 02038
USA

Tel: +1 508 541 9400
Fax: +1 508 541 9437
Email: InfoInst@dynisco.com

Dynisco Europe GmbH
Pfaffenstrasse 21
74078 Heilbronn
Deutschland

Tel: +49 7131 2970
Fax: +49 7131 23260
Email:
DyniscoEurope@dynisco.com

Dynisco Instruments S.a.r.l.
466, rue du Marché Rollay
94500 Champigny sur Marne France

Tel: +33 1 4881 8459
Fax: +33 1 4881 8334
Email: DyniscoFrance@dynisco.com

Dynisco.s.r.l.
Via Adriatico, 2/2
20162 Milano
Italia

Tel: +39 02 661 01733
Fax: +39 02 661 02908
Email: Dyniscoltaly@dynisco.com

Dynisco UK Ltd.
Unit 2B Crowood House
Gypsy Lane
Swindon SN2 8YY
Great Britain

Tel: +44 1527 577077
Fax: +44 1527 577070
Email: DyniscoUK@dynisco.com

Dynisco SPOL, S.R.O.
cp. 579
756 55 Dolni Becva
Czech Republic

Tel: +42 0571 647228
Fax: +42 0571 647224
Email: Dyniscocz@nextra.cz